

Armor Pendant

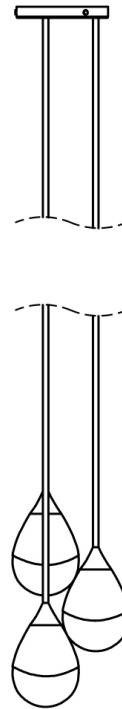

Armor Pendant Three Cluster - Small

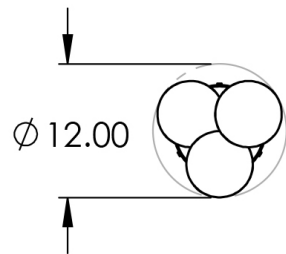
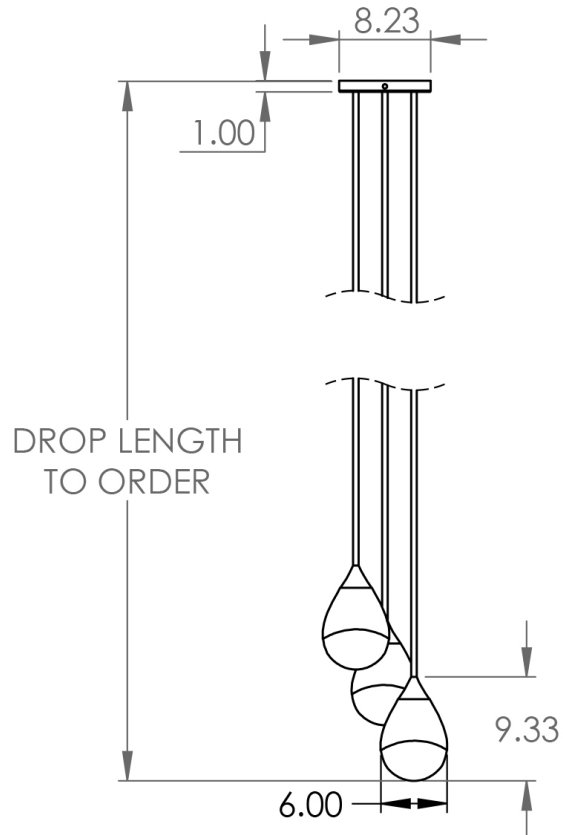

Dimensions

12"W

Drop length cut to order. Pricing includes up to 78"H. For longer drop lengths please inquire for custom quote.

Materials

hand-blown glass, brass and finished stainless steel chainmail

Finish

satin brass, antique brass, oil-rubbed bronze, satin black, satin nickel or antique nickel

Lead time

8-12 weeks

Lamping

E12 | 120V | 60W

3W dimmable LED bulb included

120V; 180 lumens; 2200k color temperature

UL listed

info@konektstudio.com

+1 (917) 261-6470

@konektstudio.com

konekt

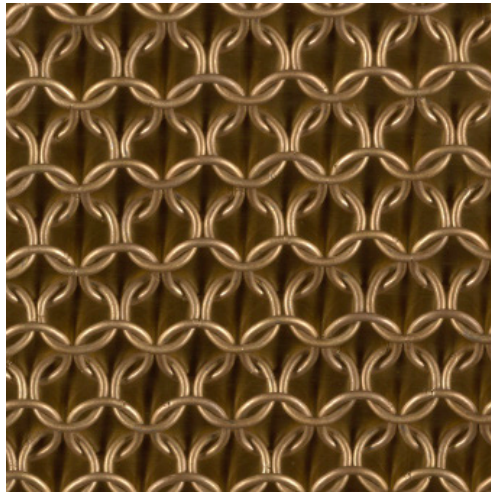

Satin Brass

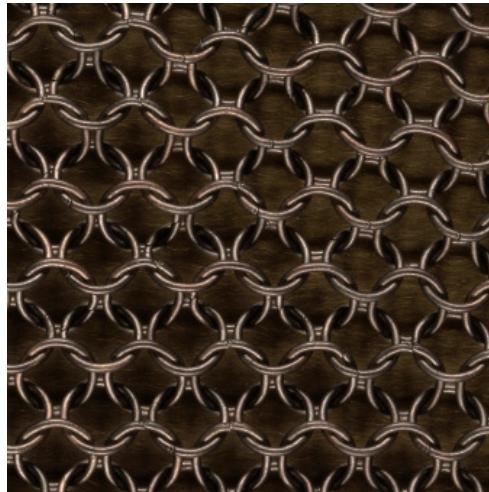

Antique Brass

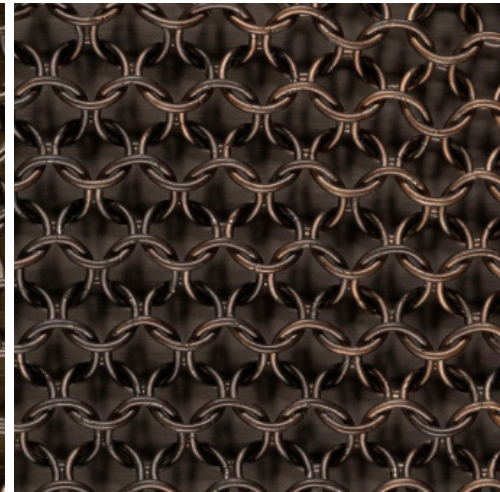

Oil-Rubbed Bronze

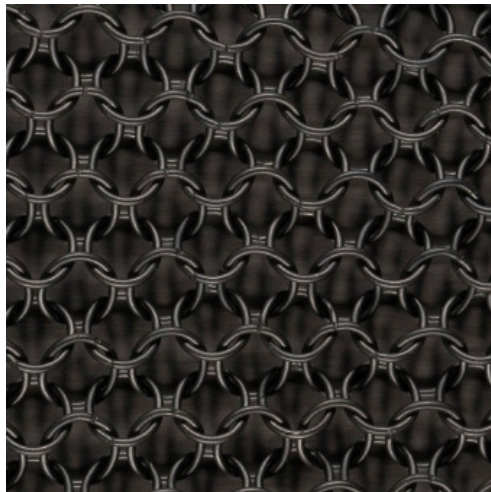

Satin Black

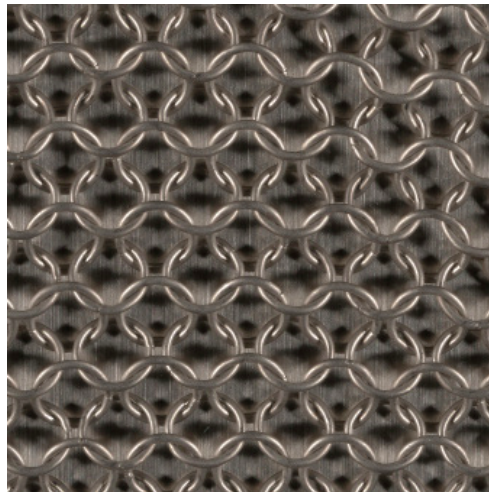

Satin Nickel

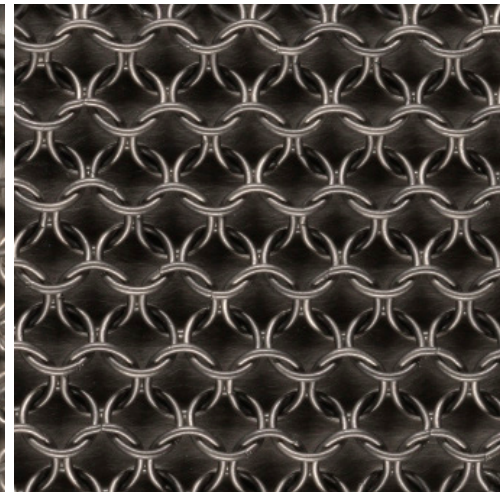

Antique Nickel