

The Rib Pendants are available in three shapes and five sizes, designed to stand alone or in various grouped arrangements. Each glass pendant is blown in Italy and delicately framed by thin brass ribs. A cylindrical brass finial, with optional hand-wrapped leather or suede, elongates the pendant and adds a finishing touch of refinement.

The collection continues Konekt's exploration of opposing characteristics — finding contrast and balance between strength and fragility, soft curves and sharp lines, adornment and moderation.

Rib Pendant - Small Sphere Double

Overall dimensions

14 5/8" L x 8"W

Pendant dimensions

8"W x 10"H

Overall drop length

Cut to order. Pricing includes up to 78"H. For longer drop lengths inquire for custom quote

Materials

Glass, brass and optional hand-wrapped leather or suede

Finishes

Satin brass, antique brass, oil-rubbed bronze, satin black, satin nickel, antique nickel or polished nickel

Leather color options

Maroon, tan, cream, fumo, mocha, or dark olive

Suede color options

Walnut, beige, or pearl

Lead time

8-12 weeks

Lamping

E12 | 120V | 60W

UL listed

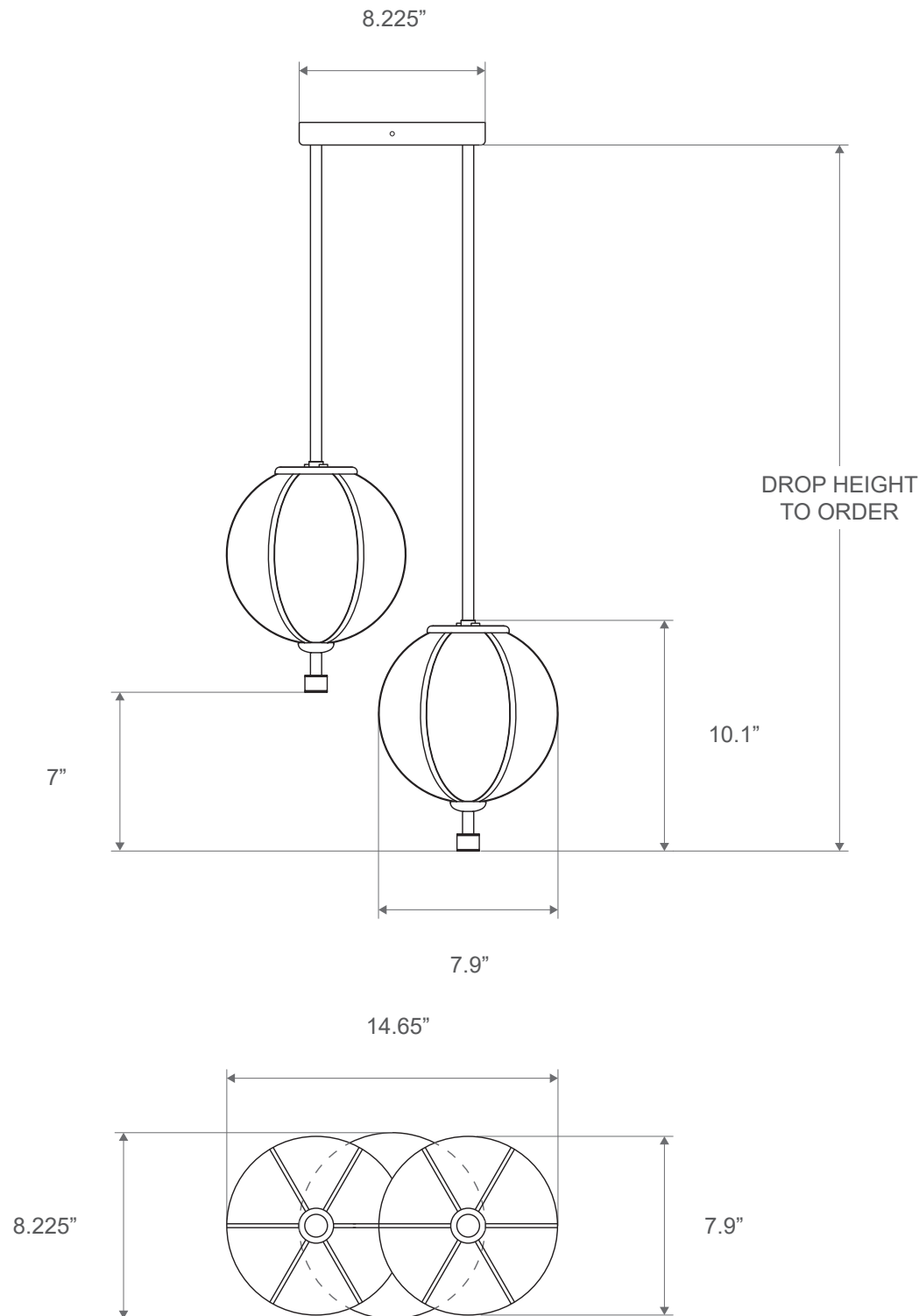

info@konektstudio.com
+1 (917) 261-6470
@konektstudio.com

konekt



Satin Brass



Antique Brass



Oil-Rubbed Bronze



Satin Black



Satin Nickel

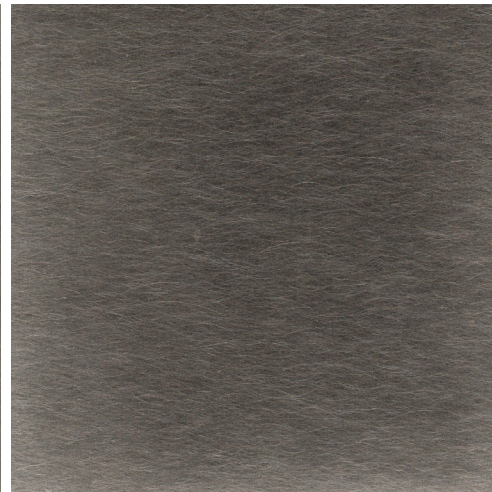

Antique Nickel



Polished Nickel



Beige Suede



Pearl Suede



Walnut Suede

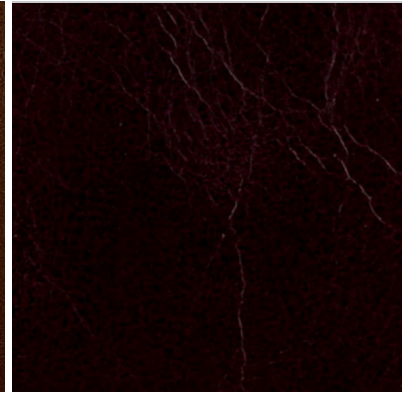

Maroon Leather (distressed)

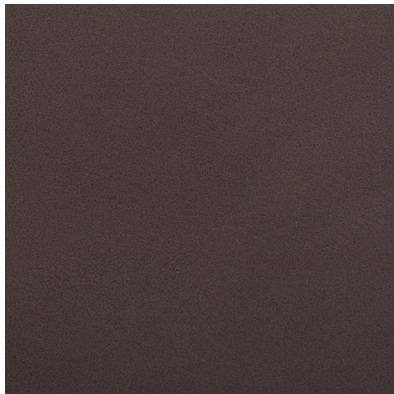

Mocha Leather



Dark Olive Leather

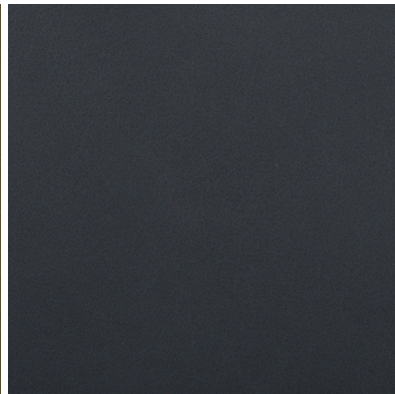

Fumo Leather

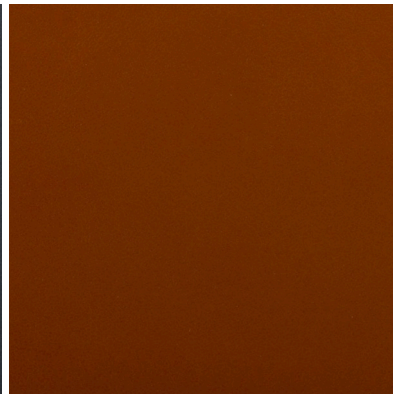

Tan Leather

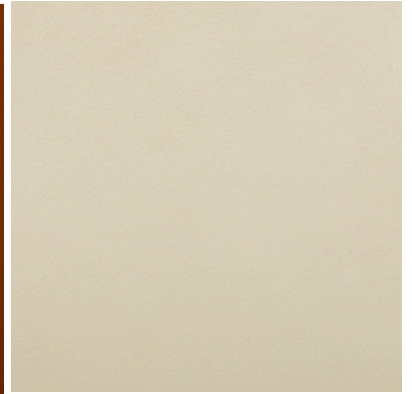

Cream Leather