

Rib Table Lamp



The Rib Table Lamps are available in two different glass shapes, each blown in Italy and delicately framed by thin brass ribs. A cylindrical brass base is wrapped in leather or suede, enhancing the rich interplay of colors and textures.

The Rib collection continues Konekt's exploration of opposing characteristics — finding balance between strength and fragility, soft curves and sharp lines, adornment and moderation.

Sphere

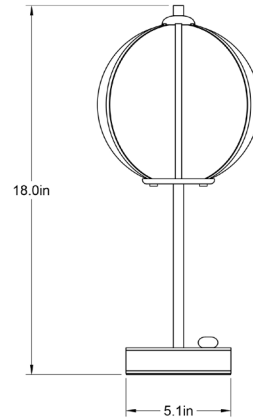
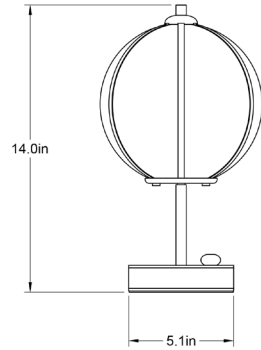
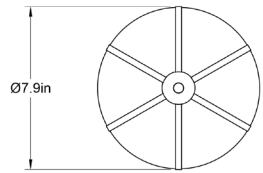

Ellipse

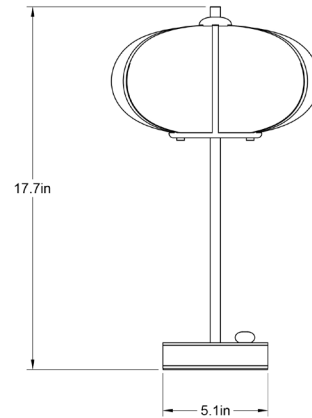
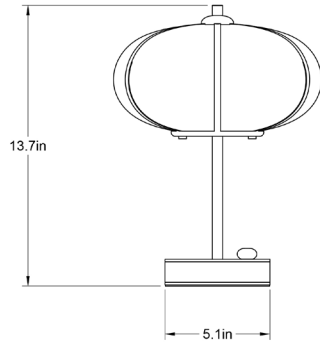
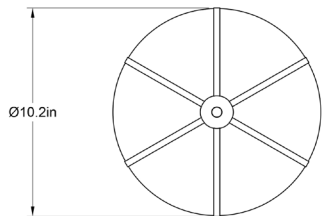

Rib Table Lamp

Dimensions

Sphere: 8"D x 14"H or 18"H

Ellipse: 10.25"D x 13.75"H or 17.75"H

Materials

Glass, brass and hand-wrapped leather or suede

Finishes

Satin brass, polished brass*, antique brass, oil-rubbed bronze, satin black, satin nickel, antique nickel or polished nickel

**polished brass is waxed and unlacquered as a live finish, allowing a natural patina to develop over time*

Leather color options

Maroon, tan, cream, fumo, mocha, or dark olive

Suede color options

Walnut, beige, or pearl

Lead time

8-12 weeks

Lamping

E12 | 120V | 60W | Dimmable

7W dimmable LED bulb included

120V; 700 lumens; 2700k color temperature

info@konektstudio.com

+1 (917) 261-6470

@konektstudio.com

konekt



Polished Brass

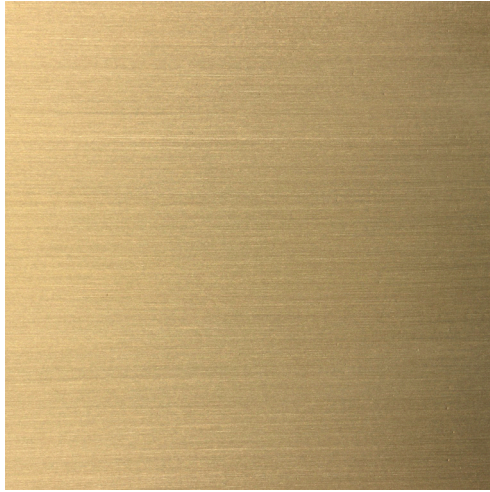

Satin Brass

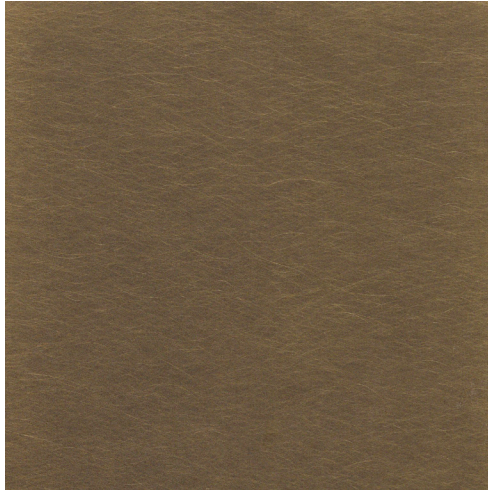

Antique Brass



Oil-Rubbed Bronze

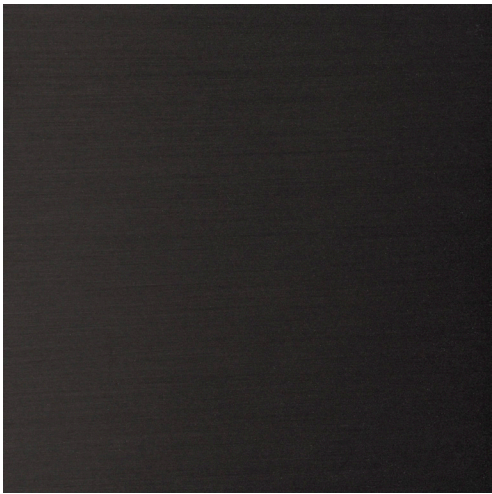

Satin Black



Satin Nickel

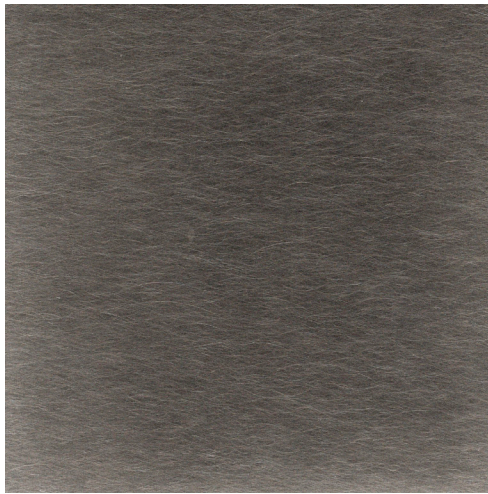

Antique Nickel

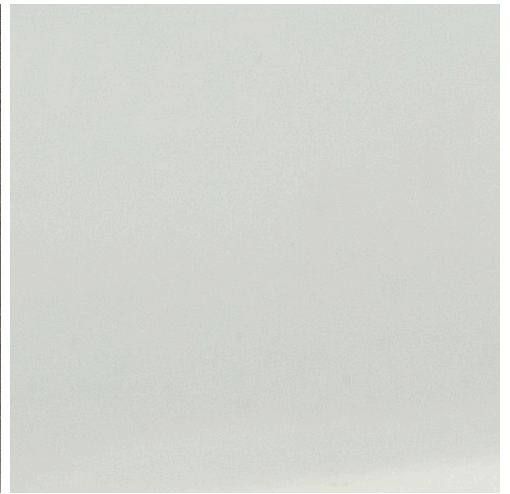

Polished Nickel



Beige Suede



Pearl Suede



Walnut Suede

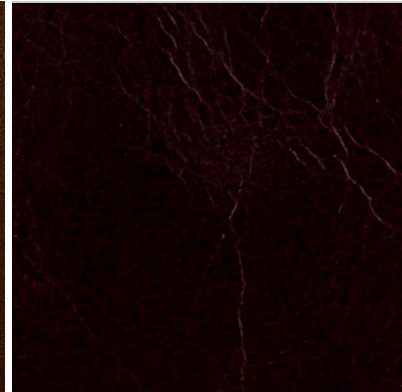

Maroon Leather (distressed)

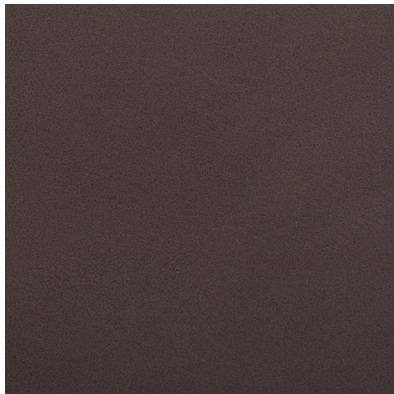

Mocha Leather



Dark Olive Leather

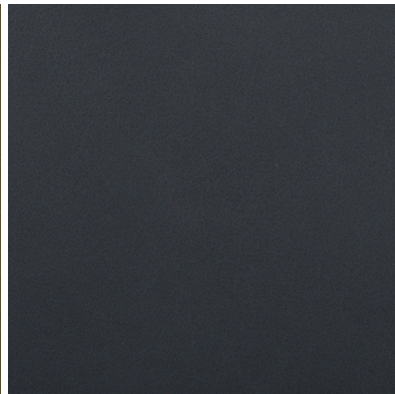

Fumo Leather

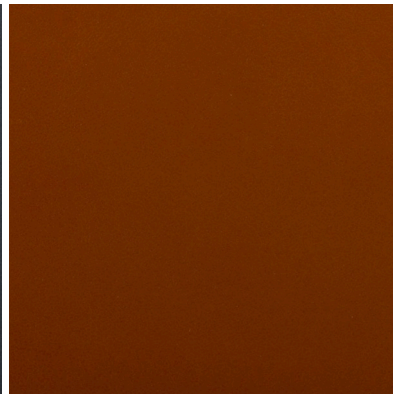

Tan Leather

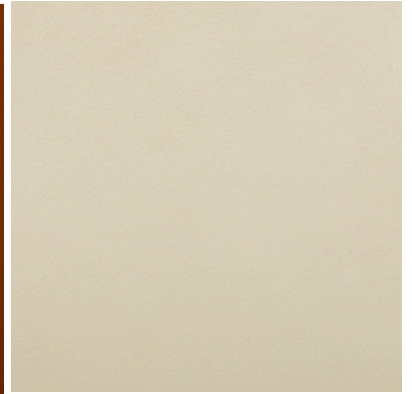

Cream Leather