

Rib Chandelier - 3 Suspension



The Rib Chandelier is anchored by a cylindrical core, hand-wrapped in leather or suede. Glass pendants, framed by slender brass ribs, extend outward to form a balanced constellation of texture, structure, and light. Available with 3 or 6 pendants, as either a suspended fixture or a flush mount.

The Rib Collection continues Konekt's exploration of opposing characteristics — finding contrast and balance between strength and fragility, soft curves and sharp lines, adornment and moderation.

Rib Chandelier - 3 Suspension

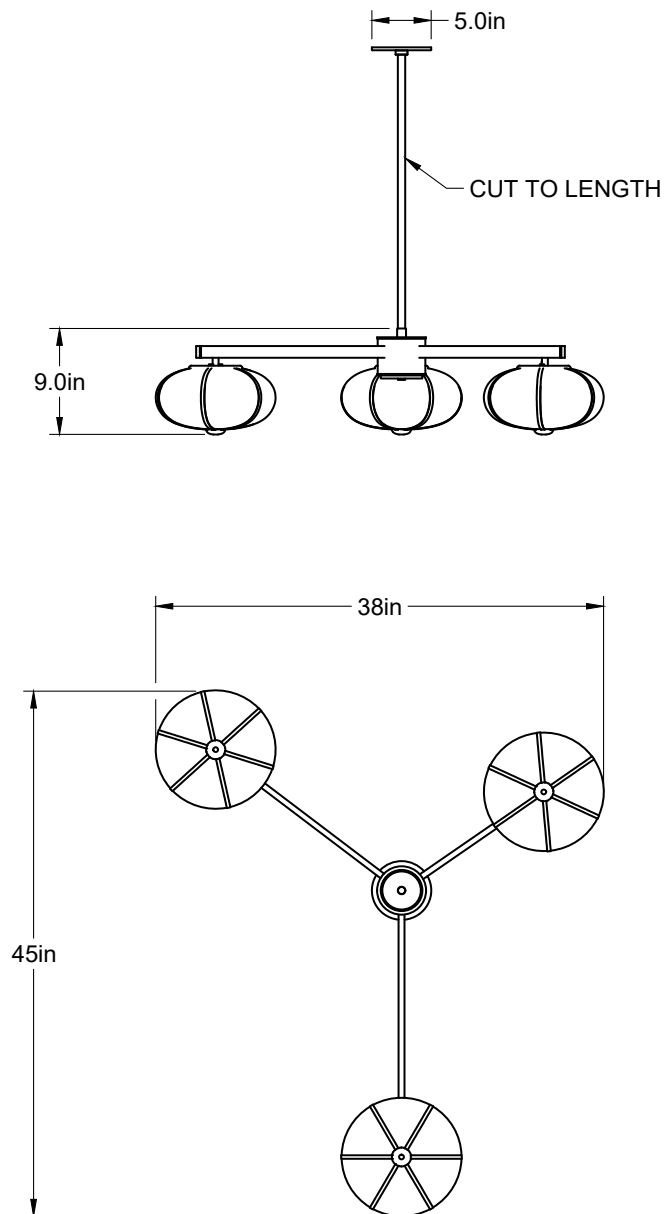

Dimensions

45"W x 38"L x 9"H

Overall drop length

Cut to order. Pricing includes up to 78"H. For longer drop lengths inquire for custom quote

Materials

Glass, brass, hand-wrapped leather or suede*

*Available without leather/suede upon request

Finishes

Satin brass, antique brass, oil-rubbed bronze, satin black, satin nickel, antique nickel, polished nickel

Leather or suede color options

Maroon, tan, cream, fumo, mocha, dark olive, walnut, beige, pearl

Lamping

120V | E12 screw base | max 40W

240V available, please inquire

Bulb included

120V: (3x) 7W dimmable LED bulb; 700 lumens; 2700K

Weight

Approx. 20 lbs

UL listed

info@konektstudio.com

+1 (917) 261-6470

@konektstudio.com

konekt



Satin Brass



Antique Brass



Oil-Rubbed Bronze



Satin Black



Satin Nickel

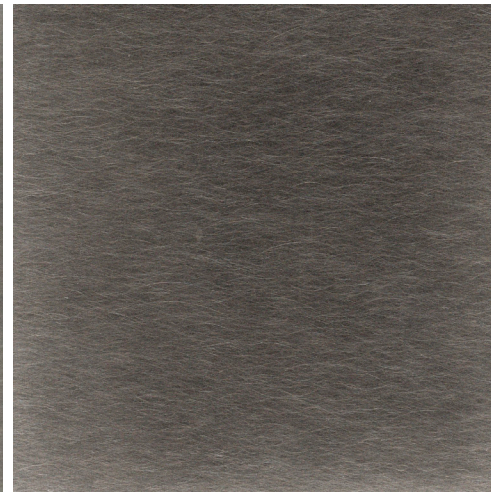

Antique Nickel



Polished Nickel



Beige Suede



Pearl Suede



Walnut Suede

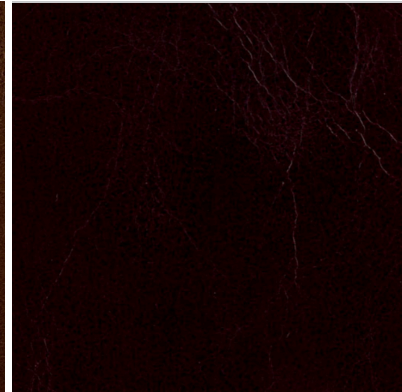

Maroon Leather (distressed)



Mocha Leather



Dark Olive Leather

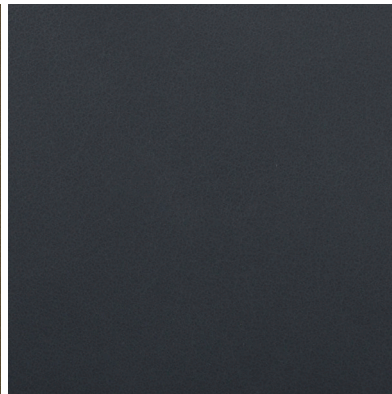

Fumo Leather

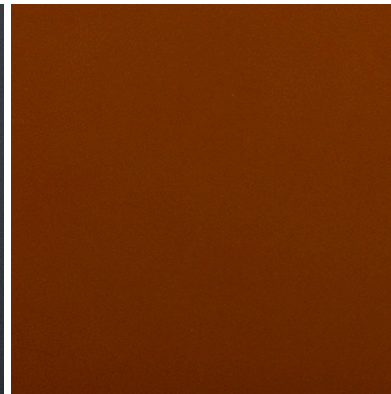

Tan Leather



Cream Leather